



UFSK INTERNATIONAL produces a wide range of dissecting tables. We plan, manufacture and mount even entire dissection room installation - turnkey! All our dissecting tables are made of stainless steel.

UFSK INTERNATIONAL produziert eine große Bandbreite an Seziertischsystemen. Wir planen, stellen her und installieren ganze Sezierräume - schlüsselfertig. Die Fertigung aller Pathologieeinrichtungen erfolgt in Edelstahl.

Dissection Tables Seziertische





Dissection Tables Seziertische

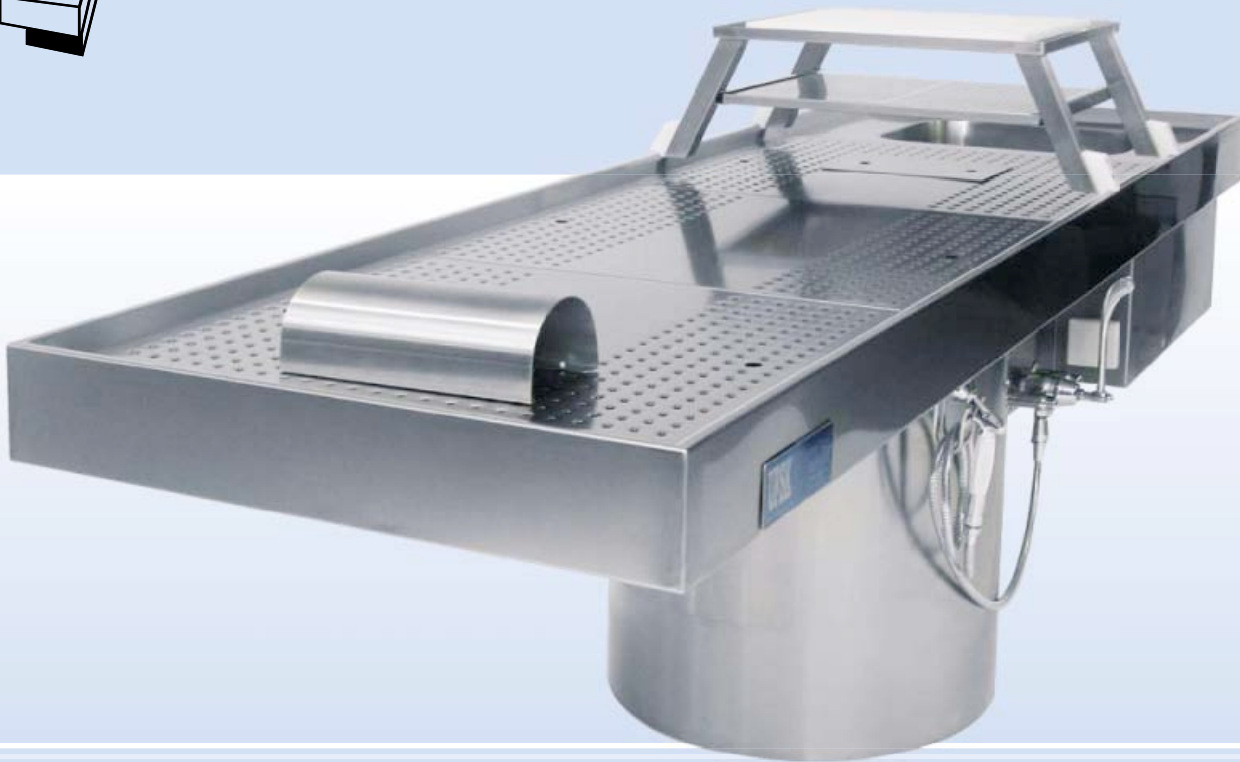

ST HS ..

The dissection tables of UFSK are manufactured completely from stainless steel. The following variations are available: height adjustable, rotatable, fixed, with or without exhaust. We also offer an extensive accessories program.

Die Seziertische von UFSK sind komplett in Edelstahl gefertigt. Folgende Varianten sind lieferbar:
Feststehend, höhenverstellbar, drehbar, mit oder ohne Absaugung.
Umfangreiches Zubehör rundet das Produktprogramm ab.

Optional: round or rectangle column
Wahlweise runde oder eckige Säule

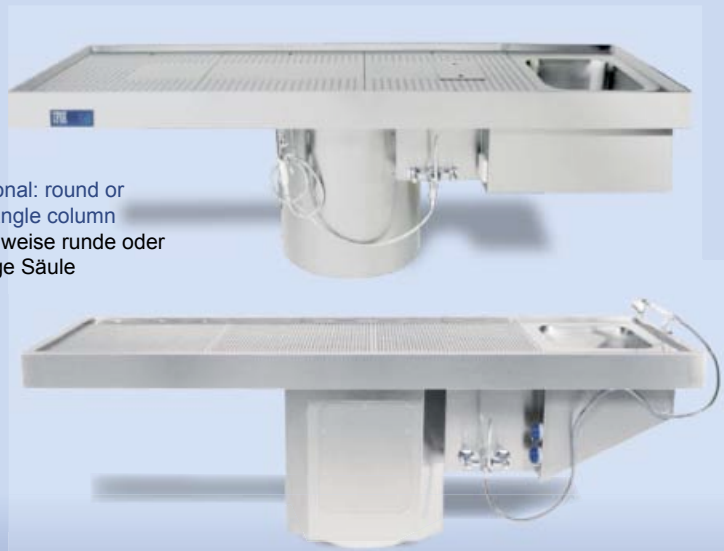







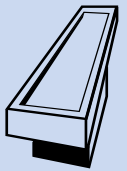

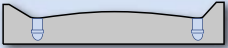

Strainer element
Restesieb im Abfluß der Arbeitsfläche



Dissection table with positive stamping and two drains
Seziertisch mit runder Säule, positiver Prägung und zwei Abläufen



Description Beschreibung	Best. Nr. Order No.	Optionals Alternativen
<p>L/W 2600 x 850 mm with round column Completely manufactured of stainless steel. Dissection plate and organ basins are smoothly from a piece. Sound-absorbing and bent in direction to drain. Water-protected plug socket. Elbow lever mixing tap for warm and cold water with hose shower. Exhaust with hose ø 250 mm by builder (or awarding authority), top side with three-part punched support.</p> <p>L/B 2600 x 850 mm mit runder Säule Vollständig aus Edelstahl gefertigt. Sezierplatte und Organbecken sind nahtlos aus einem Stück. Schallgedämmt und in Abflußrichtung geneigt. Wassergeschützte Steckdose. Kniehebelsmischbatterie für Warm- und Kaltwasser mit Schlauchbrause. Standard mit negativer Prägung. Absaugung mit Schlauch ø 250 mm bauseits, Oberseite mit 3-teiliger gelochter Auflage.</p>		<p>PS work space with positive stamping PS Arbeitsfläche mit Positivprägung</p> 
 <p>H = 750-950 mm height adjustable, 2 x 90° rotatable H = 750-950 mm höhenverstellbar, 2 x 90° drehbar</p>	ST HS 1	<p>NS work space with Negative stamping NS Arbeitsfläche mit Negativprägung</p> 
 <p>H = 850 mm, 2 x 90° rotatable H = 850 mm, 2 x 90° drehbar</p>	ST HS 2	 <p>AG perforated work plate AG Arbeitsfläche gelocht</p>
 <p>H = 750-950 mm height adjustable H = 750-950 mm höhenverstellbar</p>	ST HS 15	
 <p>H = 750-950 mm height adjustable, rotatable and air exhaust H = 750-950 mm höhenverstellbar, drehbar mit Luftabsaugung</p>	ST HS 1102	
 <p>W/D/H 2600 x 850x 750 mm, 2 x 90° rotatable and air exhaust B/T/H 2600 x 850 x 750 mm, 2 x 90° drehbar, mit Luftabsaugung</p>	ST HS 2102	
 <p>W/D/H 2600 x 850x 750 mm, fixed B/T/H 2600 x 850 x 750 mm, feststehend</p>	ST HS 3	

Accessories Zubehör



Body-holder from rubber
Körper-/Nackenhalter aus Gummi



Neckrest holder from stainless steel
Nackenzstütze aus Edelstahl



Perforated strainer basket
Gelochter Korbeinsatz für des Spülbecken



Activated carbon filter
Aktivkohlefilter



Strainer element for working plate
Restesieb für Ablauf der Arbeitsfläche
für / für HS 1, HS 2, HS 15, HS 3



Body support
Körperstütze



Dissection Tables Seziertische

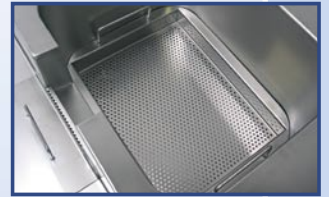

ST HS 16-02

ST HS 31-02

The dissection tables of UFSK are manufactured completely from stainless steel. The following variations are available: height adjustable, fixed, with or without exhaust. When desired the dissection tables are also available with two columns. An effective sprinkler system cleans continuously the inside working area. We also offer an extensive accessories program.

Die Seziertische mit eckiger Säule sind komplett in Edelstahl gefertigt. Sie erhalten Sie in den Variationen drehbar, höhenverstellbar, mit Absaugung. Auf Wunsch sind die Seziertische auch mit zwei Säulen lieferbar. Ein wirkungsvolles Sprinklersystem reinigt kontinuierlich den Wannensboden. Umfangreiches Zubehör rundet das Produktprogramm ab.







ST HS 16-02 with optional organ table
ST HS 16-02 mit optionalem Organtisch

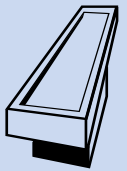

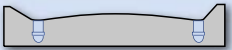
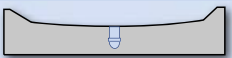
Tunnel for fast water drain
Tunnel für optimierten Wasserablauf





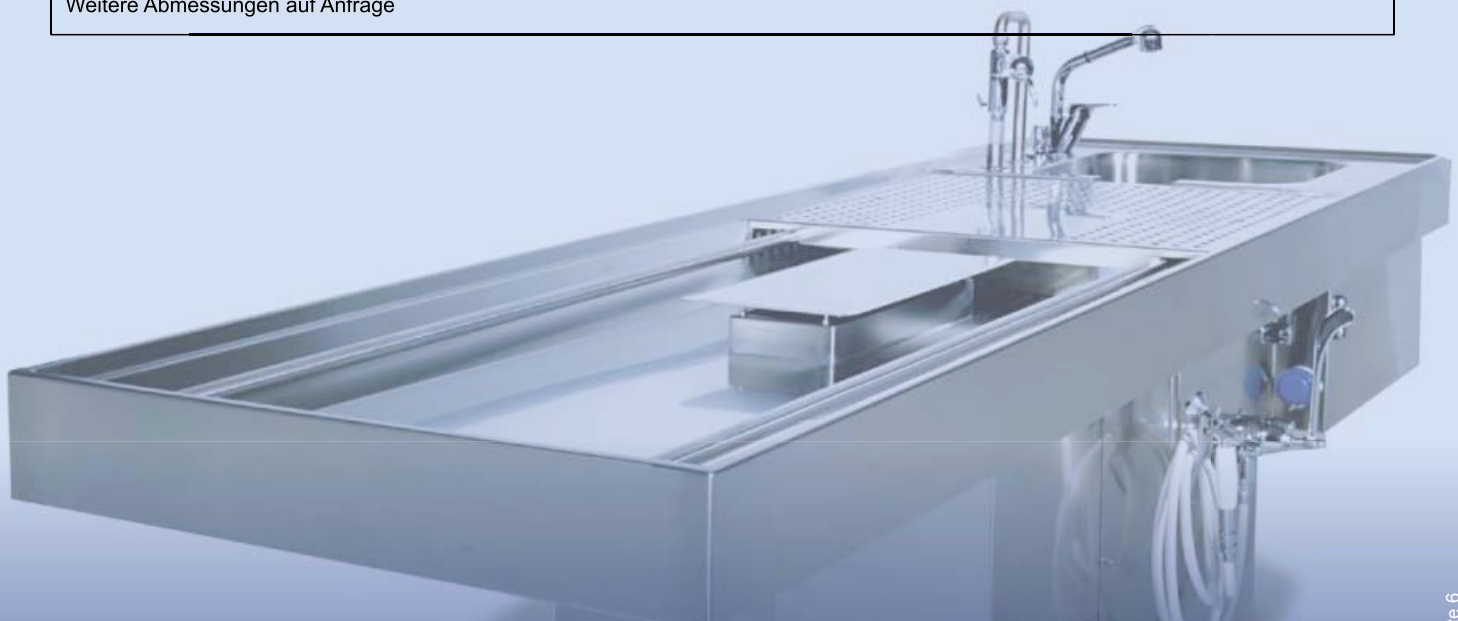



Description Beschreibung	Best. Nr. Order No.	Optionals Alternativen
<p>L/W 2600 x 850 mm with rectangular column Completely made of stainless steel dissection plate and organ basins are smoothly from a piece. Sound-absorbing and bent in direction to drain. Water-protected plug socket. Elbow lever mixing tap for warm and Cold water with hose shower. Exhaust with hose \varnothing 250 mm by builder (or awarding authority), top side with three-part punched support. Organ sink 500 x 400 x 300 mm deep with tunnel for a fast and comfortable water drain. Exhaust dome 400 x 150 mm.</p> <p>L/B 2600 x 850 mm mit rechteckiger Säule Vollständig aus Edelstahl gefertigt. Sezierplatte und Organbecken sind nahtlos aus einem Stück. Schallgedämmt und in Abflußrichtung geneigt. Wassergeschützte Steckdose. Kniehebelsmischbatterie für Warm- und Kaltwasser mit Schlauchbrause. Absaugung mit Schlauch \varnothing 250 mm bauseits, Oberseite mit 3-teiliger gelochter Auflage. Organbecken 500 x 400 x 300 mm tief mit Tunnel zur Wanne, Absaugdom 400 x 150 mm.</p>		<p>PS work space with positive stamping PS Arbeitsfläche mit Positivprägung</p>  <p>NS work space with Negative stamping NS Arbeitsfläche mit Negativprägung</p> 
 <p>H = 850 mm, fixed Höhe 850 mm, feststehend,</p>	ST HS 31-02	<p>AG perforated work space AG Arbeitsfläche gelocht</p> 
 <p>H = 750-950 mm height adjustable Höhenverstellbar von 750 bis 950 mm, Absaugdom 400 x 150 mm,</p>	ST HS 16-02	
<p>Other dimensions on request Weitere Abmessungen auf Anfrage</p>		



On request with two columns
Auf Anfrage mit 2 Säulen



	Hose pistol Handbrause (Sprühpistole)
	Comfort hose Komfortbrause
	Hydro aspirator Hydroaspirator
	Macerator Abfall- zerkleinerer
	Strainer Restesieb
	Strainer basket Korbeinsatz

	Body Neckholder, PVC Körper- Nacken- halter aus PVC
	Neck roll, stain- less steel Nackenrolle, Edelstahl
	Organ table Organtisch
	Body support, perforated, stainless steel, 4 pcs. Körperstütze, Edelstahl, gelocht, 4 St.
	Sprinkler irrigation Sprinkleranlage
	Activated carbon filter Aktiv-Kohlefilter

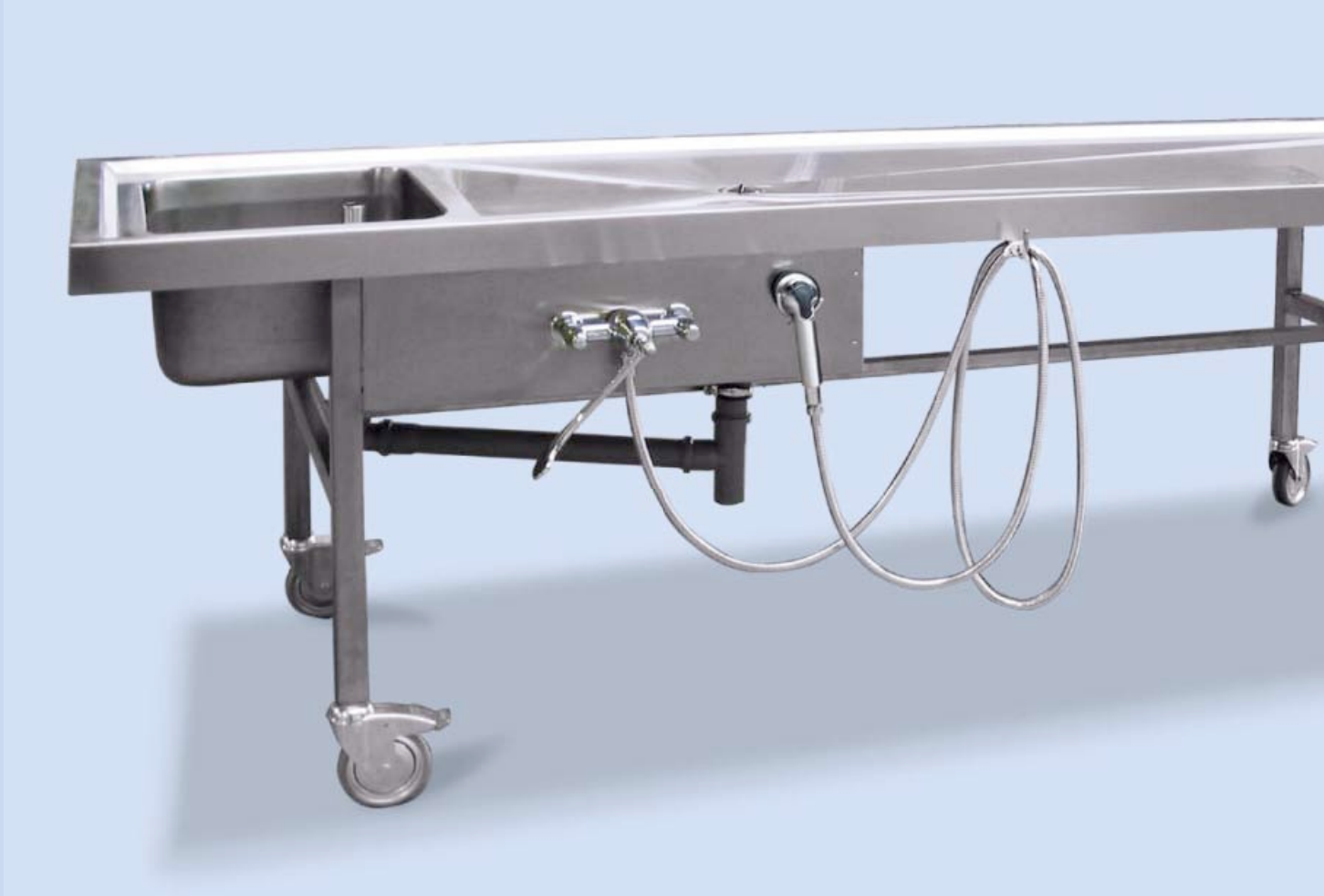
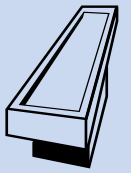

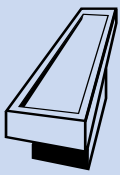

Autopsy Table Seziertisch



ST HS 4 M

ST HS 5 M

The autopsy table is completely made of stainless steel. Dissection plate and organ basins are smoothly from one piece. Sound-absorbing and bent in direction to drain. Elbow lever mixing tap for warm and cold water with hose shower, mounted at a lateral blind. The expirations are united under the table, the filter insets of the expirations are to take out.

- Basin L/W/H 400 x 500 x 250 mm

Der Seziertisch ist komplett aus Edelstahl (Werkstoff Nr. 1.4301) mit Unterbau aus stabilen verwindungssteifen Edelstahlprofilen ausgestattet. Er verfügt über eine Mischbatterie an einer seitlichen Blende. Die Auflagefläche hat einen hohen umlaufenden Profilrand sowie ein nahtlos eingearbeitetes Spülbecken. Die Tischplatte ist diagonal geprägt und hat ein Gefälle zum Ablauf hin. Die Abläufe sind unter dem Tisch zusammengeführt, die Siebeinsätze der Abläufe sind herausnehmbar.

- Waschbecken L/B/H 400 x 500 x 250 mm



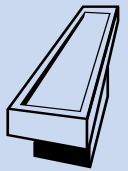

		Best. Nr. Order No.
L/W/H 2600 x 750 x 850 mm weight approx. 80 kg L/B/H 2600 x 750 x 850 mm Gewicht ca. 80 Kg		
	Fixed Feststehend	ST HS 4 M
	Movable on 4 lockable rollers \varnothing 125 mm Fahrbar auf 4 feststellbaren Lenkrollen \varnothing 125 mm	ST HS 5 M
Other dimensions on request Weitere Abmessungen auf Anfrage		

Accessories Zubehör



Body-holder from rubber
Körperhalter aus Gummi



Neckrest holder, stainless steel
Nackenkstütze aus Edelstahl



Bodysupport (4 Pcs)
Körper-Auflage (4 St.)



Bucket with lid, stainless steel
Edelstahleimer mit Henkel



Hose pistol
Handbrause



Organ table
Organtisch



Washing and Autopsy Table Wasch- und Seziertisch



ST HS 6

ST HS 7

Table and lower section entirely from stainless steel.
Table top with fringe overall and projecting inclined in direction to sink.
Choose either the fixed or movable type.

Tischplatte und Unterbau vollständig aus rostfreiem Edelstahl.
Die Tischplatte verfügt über eine Randlippe und Gefälle zum Ablauf.
Wahlweise fahrbar oder feststehend lieferbar.



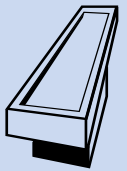

		Best. Nr. Order No.
L/W/H 2150 x 750 x 850 mm weight ca. 70 kg L/B/H 2150 x 750 x 850 mm Gewicht ca. 70 Kg		
	Fixed Feststehend	ST HS 6
	Movable on 4 locktype rollers \varnothing 125 mm Fahrbar auf 4 feststellbaren Lenkrollen \varnothing 125 mm	ST HS 7
Other dimensions on request Weitere Abmessungen auf Anfrage		

Accessories Zubehör



Bucket with lid, stainless steel
Edelstahleimer mit Henkel



Organ table
Organtisch

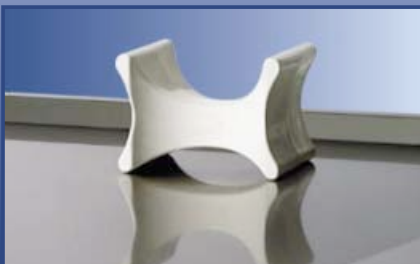

Body-holder from rubber
Körperhalter aus Gummi



Neckrest holder, stainless steel
Nackenstütze aus Edelstahl



Bodysupport
Körper-Auflage

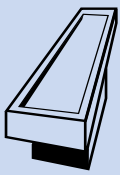

Washing and Embalming Table Wasch- und Präparierstation



ST 8043

Description Beschreibung	Optionals Optional	Best. Nr. Order No.
<p>Docking Station Rectangular docking station, fixed and made of stainless steel. Easy joining of the movable preparation table (ST HS 7) via docking assistance</p> <p>Docking Station Rechteckige Andock-Säule, fest installiert, Edelstahl. Einfaches Anfahren einer Seziertischplatte (ST HS 7) über eine Anfahrhilfe mittels Führungsbügel</p>	<ul style="list-style-type: none"> • Tap and hose shower • Mischbatterie und Brauseschlauch 	<p>ST 8043</p>



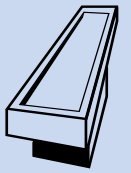

HT 2000 ST

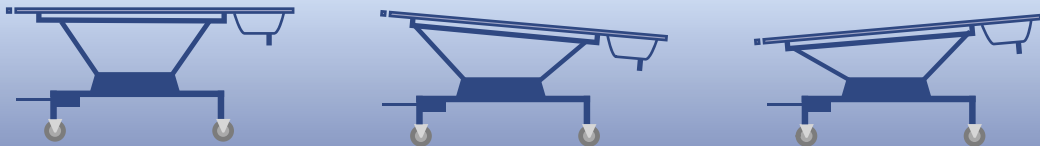
Description Beschreibung	Best. Nr. Order No.
<p>Hydraulic body tray lifter, ideal for „small“ clinics Rugged, torsion-free frame, grey powder-coated. Mobility is the major advantage for small pathologies. The lifting trolley can be easily pushed or pulled. Via the pedal hydraulic one can set shock position for ease emptying the dissection tray. Delivered including the dissection tray. Length 2.60 m.</p> <p>Der äußerst leicht fahrbare Hub- und Transportwagen HT 2000 ist ideal auf kleine Pathologien zugeschnitten, denn er hat den Vorteil, ein mobiler Seziertisch zu sein. Mit der integrierten Seziertischplatte ist er der ideale Allrounder in der Pathologie. Über die manuelle Fußhydraulik kann stufenlos Schock- und Gegenschocklage zur leichteren Wannentleerung eingestellt werden. Die Lieferung erfolgt komplett mit Waschtischauflage. Länge 2,60 m.</p> 	<p>HT 2000 ST</p>



Hydraulic Pedals, Lockable rollers
Die Hydraulik-Pedale, arretierbare Rollen

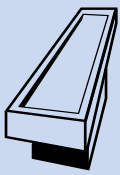

Photo Table Foto-Tisch



PE FT 01C

		Best. Nr. Order No.
<p>Operating table from stainless steel, suitable to x-ray screening. Overall size LWH 1400 x 800 x 800 mm Receptive area 900 x 550 mm</p> <p>Scope of supply</p> <ul style="list-style-type: none"> • Repro-column, Hand-lever, Repro arm • Overflow valve, Lacking valve, Flexible connection hose for discharge water • Transformer • Plug suitable for humid area • Guide rollers \varnothing125 mm with brake • Repro illumination • Mixing battery with elastic hose • Luminous glass-plate to rec. colour foils • Operating area • Reservoir • Pedestral support base • Add-on screen lights • Fluorescent tubes 	<p>Fototisch für optimales Arbeiten beim Zuschneiden und Präparieren histologischer Präparate, auch für kleine Sektionen geeignet. Vorbereitung für Durchleuchtung. Anschlüsse bauseits. Gesamtgröße LBH 1400 x 800 x 800 mm Aufnahmefläche 900 x 550 mm</p> <p>Lieferumfang</p> <ul style="list-style-type: none"> • Kamerastativ, Reprosäule mit Handkurbel • Überlaufrohr, Absperrhahn, flexibler Abwasserschlauch • Transformator • Feuchtraumsteckdose • 125 mm Lenkrollen, bremsbar • Repro Beleuchtungssystem Tageslichtqualität ca. 5000°K zum direktem Fotografieren geeignet (keine Zusatzleuchten notwendig) • Mischbatterie, ausziehbarer Brauseschlauch • Klarsichtplatte zur Aufnahme von Folien • Arbeitsfläche • Aufnahmewanne • Sockelunterbau • Anbaurasterleuchten • Untertischbeleuchtung mit Leuchtstoffröhren 	PE FT 01C





Dissection Tables, Examples Seziertisch-Beispiele



PREMED PHARMA KFT.
CÍM 2040 Budaörs, Gyár u. 2.
TELEFON 06 23 889 700
FAX 06 23 889 710
E-MAIL info@premedpharma.hu
WEB www.premedpharma.hu

