

Refraction unit

OPHTHALMIC UNITS

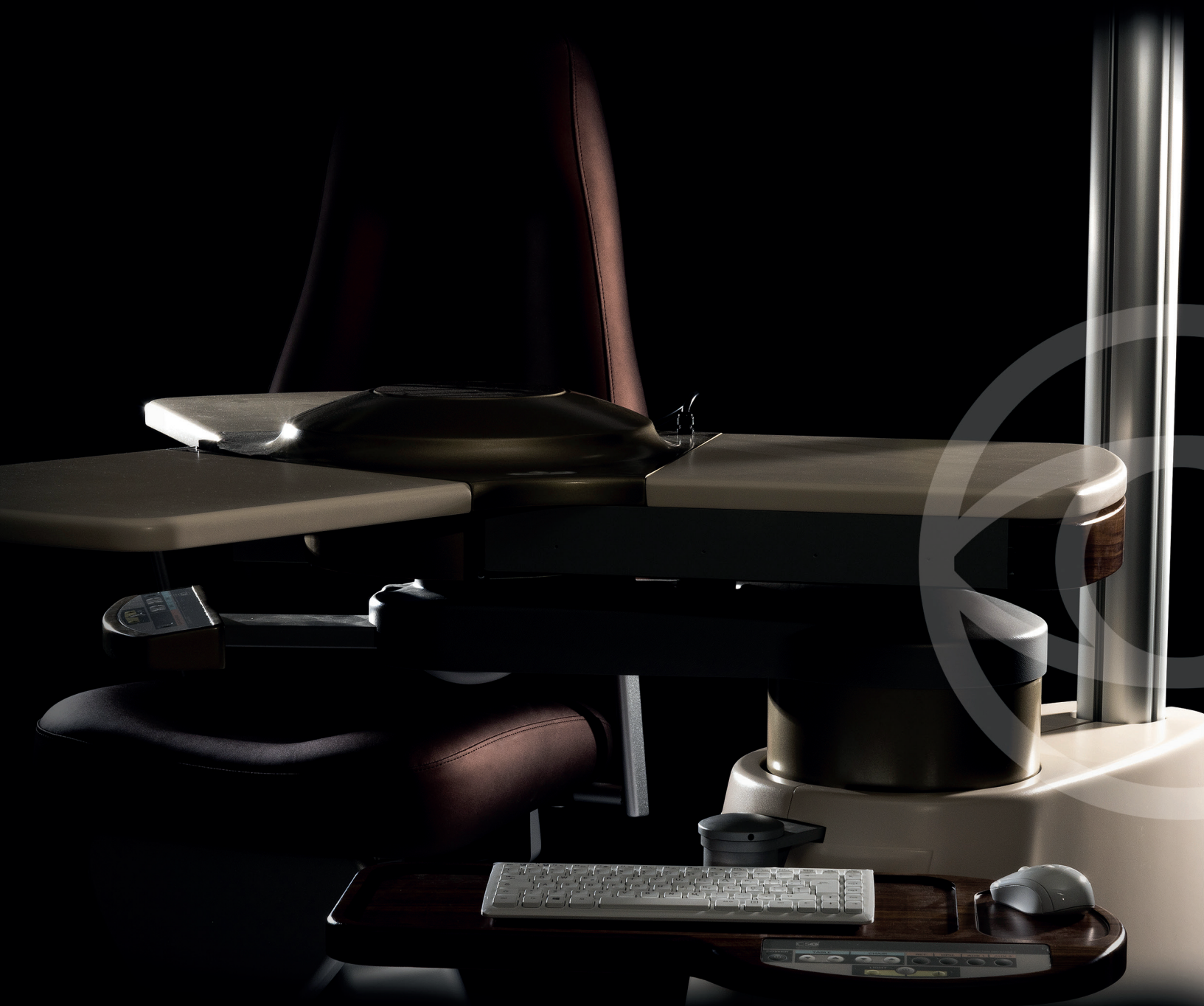



C.S.O. was established in 1967 as ophthalmological devices producer and soon becomes a world leader company for the production of a wide range of ophthalmological products.

The refraction units by C.S.O. are born at the beginning of the 90s to gather several ophthalmic devices in one solution characterized by harmonious lines, compact, ergonomic and long-lasting structure,

The C.S.O. refraction units are characterized by their practicality compatible with a wide range of devices for the modern ophthalmological diagnostic and they provide a pleasant daily working experience.

Thanks to an attentive selection of the materials used for the construction and a wide range of available colors and customizations, it is possible to realize a harmonious and comfortable working environment for the user and the patient.



Thank you for choosing C.S.O. as your supplier.



OPHTHALMIC UNIT

Future

DELUXE 2 | DELUXE 3

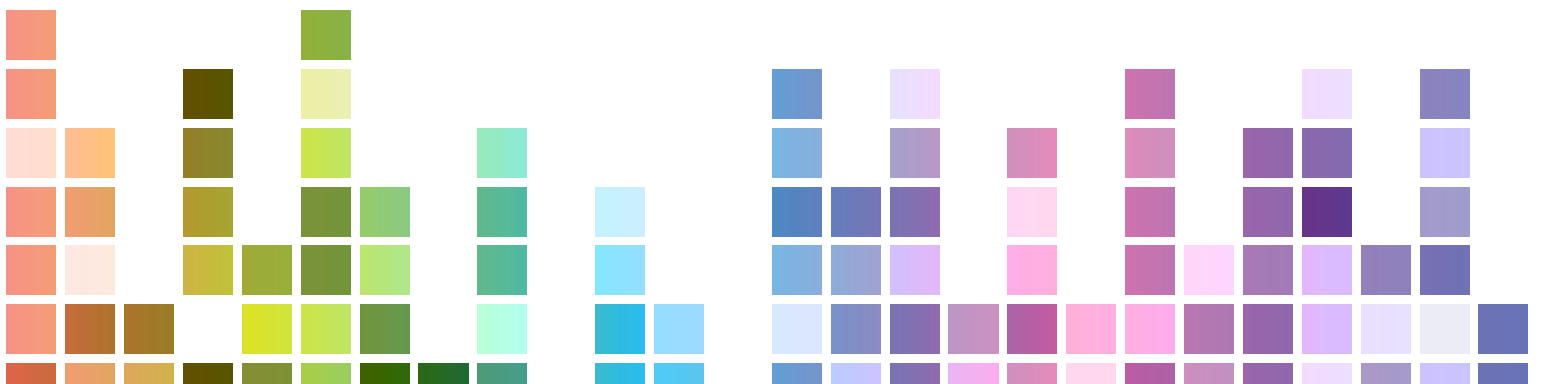

REFRACTION UNIT

FUTURE DELUXE 2 - FUTURE DELUXE 3 it is a unit with electric translation instruments plan available in two versions, with 2 or 3 ophthalmic devices (FUTURE 2 - FUTURE 3). The working plane is equipped with a drawer for the tonometer and a ceiling light with 3 LED lights. It is equipped with 2 new generation shatterproof touch-pad consoles, backlit, easy to use and to clean; on the consoles there are all the main commands and it is also possible to memorize all the functions of the device for an easy and

comfortable daily use. The FUTURE refraction units are customizable with special materials (glass, wood, Corian® etc.), and are characterized by an innovative and ergonomic design. As the whole range of CSO ophthalmic units, FUTUREit is customizable with a wide colors range.

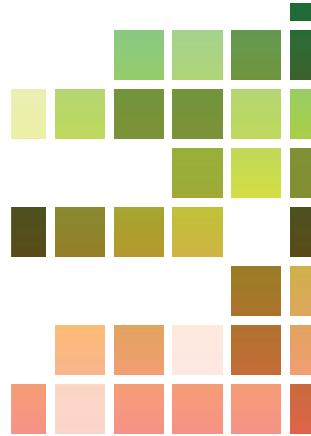

Unit with desk and
- customized drawer with wood marquetry



Touch-sensitive keyboard



Color and base backlit
(optional)

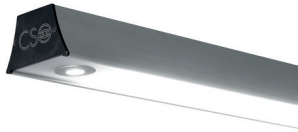

Ceiling light with three light sources suitable for every unit
with:

- LED light with adjustable intensity
- with light spot
- upper ambient LED light (optional)

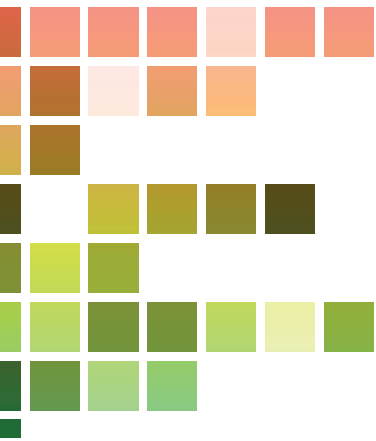

Refraction units with backlit base (optional)



Wide range of available colors (optional)



Drawer for Tonometer compartment

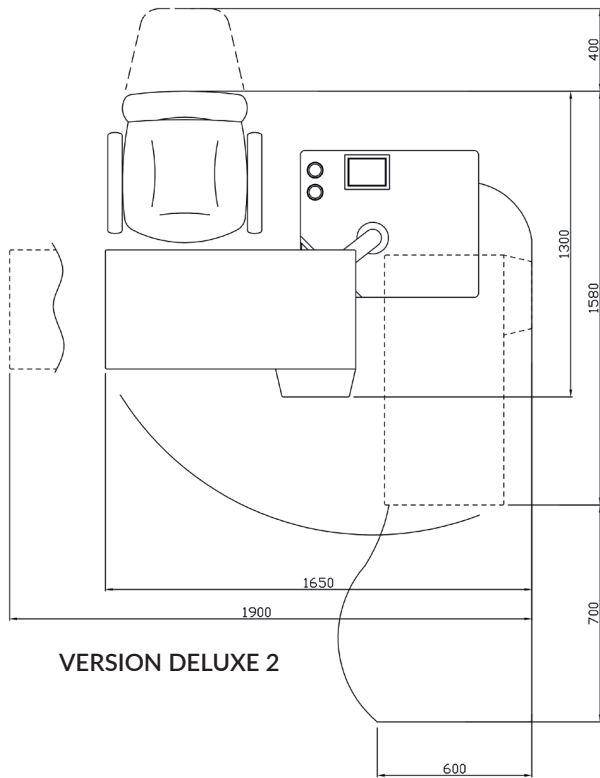

VERSION DELUXE 2

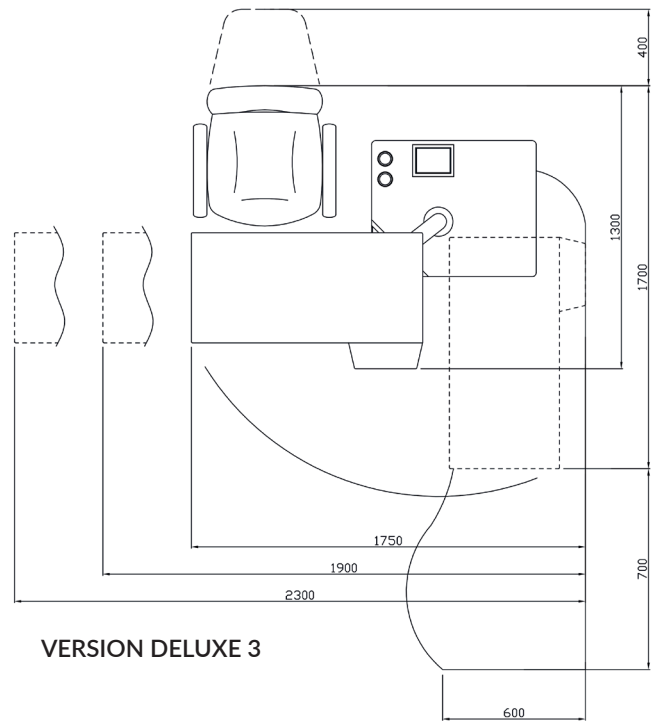

VERSION DELUXE 3

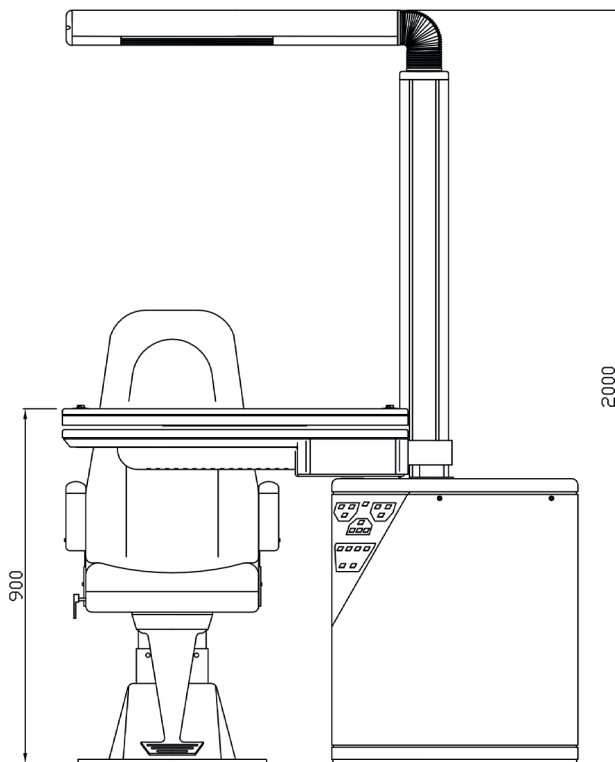

STANDARD EQUIPMENT

- Structure with support plane for 2 or 3 electronica movable instruments
- Ceiling light with 3 LED lights
- Column with projector compartment
- 2 commands consoles
- Drawer for Tonometer compartment
- Preparation of commands to stand electrical anteroposterior

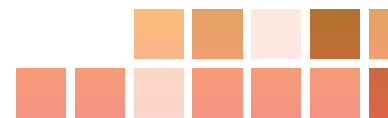

ACCESSORIES (OPTIONAL)

- Chair with electronic height adjustment
- Self-balancing arm for phoropter
- Wood's lamp with self-balancing arm
- Auxiliary spot
- Arrangement video system
- LCD monitor support
- Predisposition plane for auto refractometer
- Illuminated base
- Various supports for column
- Version with opening on the left
- Desk
- Drawers
- Finishing with special materials

ELECTRICAL DATA

	From	To
Supply voltage	90 V	264 V
Power frequency	47Hz	63Hz
Network fuses	4A T 5x20mm	8A T 5x20mm
Auxiliary sockets (chair and auxiliaries)	110Vac 50Hz	230Vac 60Hz
Max power absorbed by the auxiliary sockets	100 VA	100 VA
Max power absorbed by the unit:	600 VA	600 VA
Voltage for the table instruments	from 0 Vac to 24Vac Ophthalmometer Slit Lamp from 0Vac or 24Vac Fixation point of the Chin rest 230 Vac for other diagnostic instrument (3 instruments version)	

Accessories



Phorofter arm
cod. 100805-02

Plate for projector (not CSO)
cod. 100805-05

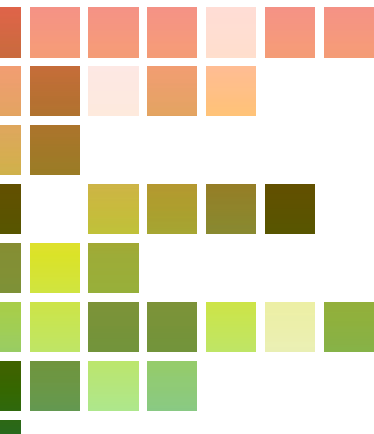

Movable spotlight
cod. 100811550

Plane for column monitor
cod. 100805-03



Ophthalmic headband support
cod. 100805-21



CD monitor support
100805-24

Phorofter support for square section column
cod. 100805-10



Lamp with 3 LED lights
cod. 100819510



**Support for column
retinoscope/ophthalmometer**
cod. 10080518



COLORS*

They make the difference and give personality to the studio furniture.

COLORS LACQUERED - optional

		
cod. 107	cod. 132	cod. 135
		
cod. 156	cod. 162	cod. 223
		
cod. 218	cod. 208	cod. 187
		
cod. 757/296-D	cod. 182	cod. 131
		
cod. 118	cod. 120	cod. 130
		
cod. 228	cod. 236	cod. 849
		
cod. 945/C	cod. 244	cod. 259

LACQUED COLORS - standard

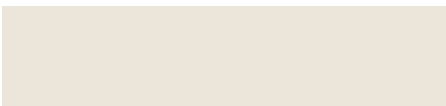
		
cod. 757/296-E	cod. 889/F	cod. 857/C

* The colors are just approximate.
Intensity color variations can be caused by the chemicals reactions of the used matters.

The specifications and the images are not contractually binding and can be modified without notice.



YOUR PROFESSIONAL PARTNER SINCE 1967



PREMED PHARMA KFT.
CÍM 2040 Budaörs, Gyár u. 2.
TELEFON 06 23 889 700
FAX 06 23 889 710
E-MAIL info@premedpharma.hu
WEB www.premedpharma.hu

